

STATUS





**X 3567**  
SZAFKA  
/ CUPBOARD  
2008X421X1167

**X 3567**  
SZAFKA  
/ CUPBOARD  
2008X421X1167

**X 05**  
STÓŁ  
/ TABLE  
2400X1200X760



**34 / KASZTAN / CHESTNUT**

\* melamina/  
melamine

**X 2167**  
SZAFKA  
/ CUPBOARD  
2008X421X815

**X 16**  
PRZYSTAWKA  
/ extension  
600X1270X760



**XKR 13**  
KONTENER  
/ PEDESTAL  
484X635X602

**X 01**  
BIURKO  
/ DESK  
2000X1000X760



23 / ORZECH / NUT

\* melamina/  
melamine

X 3119

SZAFKA  
/ CUPBOARD  
2496X421X1167



X 06 + X 08  
STÓŁ / TABLE 2000X1400X760 STÓŁ / TABLE 2000X1400X760



34 / KASZTAN / CHESTNUT

\* melamina/  
melamine

X 3679

SZAFKA  
/ CUPBOARD  
1520X421X1167



**XKR 12**  
KONTENER  
/ PEDESTAL  
484X635X602

**X 02**  
BIURKO  
/ DESK  
1700X970X760



X 17

STOLIK KAWOWY  
/ COFFEE TABLE  
1000X550

X 5567

SZAFKA  
/ CABINET  
2008X421X1871

X 01

BIURKO  
/ DESK  
2000X1000X760

X 14

PRZYSTAWKA  
/ EXTENSION  
600/800X1200X760



31 / DĄB KANADYJSKI / OAK

\* melamina/  
melamine

X 17

STOLIK KAWOWY  
/ COFFEE TABLE  
1000X550

X 5567

SZAFKA  
/ CABINET  
2008X421X1871



**X 15**

PRZYSTAWKA  
/ EXTENSION  
600X1274X760

**X 01**

BIURKO  
/ DESK  
2000X1000X760

**XKR 13**

KONTENER  
/ PEDESTAL  
484X635X602

SCHEMAT rozmieszczenia mediaportów  
 MEDIAPORT PLACEMENT SCHEME

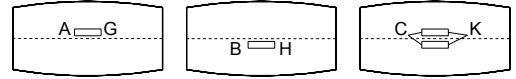

BIURKA  
 DESKS

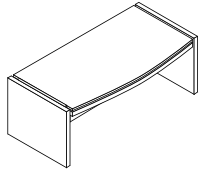

X 01  
 2000X1000X760

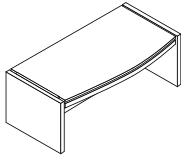

X 02  
 1700X970X760

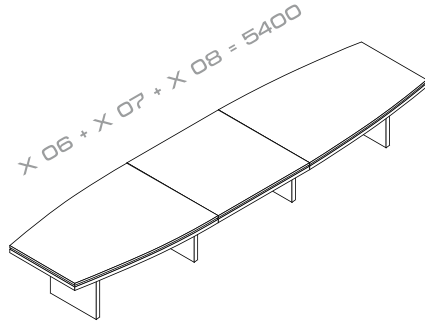

STOŁY KONFERENCYJNE  
 CONFERENCE TABLES

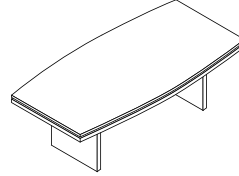

X 05  
 2400X1200X760

MEDIAPORT:  
 A,C / G,K

DODATKI DO STOŁÓW  
 KONFERENCYJNYCH  
 (MEDIAPORTY)



S91E  
 267X110X93



S92E  
 426X110X93

STOLKI KAWOWE  
 COFFEE TABLES



X 17  
 Ø1000X550



X 19  
 Ø800X550

PRZYSTAWKI  
 EXTENSIONS

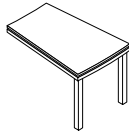

X 14  
 600/800X1200X760

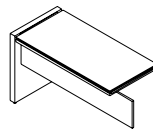

X 15  
 600/1270/760

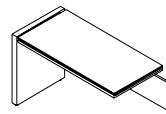

X 16  
 600/1270/760

KONTENERY  
 PEDESTALS



XKR 12  
 484X635X602



XKR 13  
 484X635X602

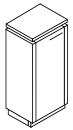

X 36  
 544X421X1167

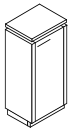

X 37  
 544X421X1167

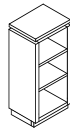

X 39  
 544X421X1167

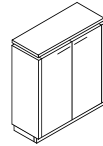

X 31  
 1032X421X1167

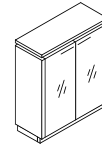

X 35  
 1032X421X1167

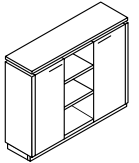

X 3679  
 1520X421X1167



34 / KASZTAN / CHESTNUT

SZAFY  
 CABINETS

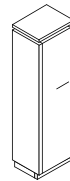

X 56  
 544X421X1871



X 57  
 544X421X1871

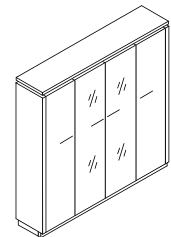

X 5567  
 2008X421X1871

Producent zastrzega sobie prawo do wprowadzenia zmian w prezentowanych wyrobach i ich oznaczeniach, nie zmieniając ich ogólnego charakteru. Katalog w rozumieniu prawa nie stanowi oferty i jest publikowany jedynie w celach informacyjnych. Zamówienia można składać wyłącznie w oparciu o aktualne cenniki dostępne u autoryzowanych dystrybutorów. Szczegóły na stronie [www.mdd.pl](http://www.mdd.pl).

The manufacturer reserves the right to introduce alterations to the products and their marking without changing the general design. The present catalogue does not constitute a legally binding offer and is published solely for information purposes. Orders may be placed only on the basis of the current price lists, available at authorized distributors. More details can be found at [www.mdd.pl](http://www.mdd.pl).

a - SZEROKOŚĆ, B - GŁĘBOKOŚĆ, C - WYSOKOŚĆ  
 a - LENGTH, B - WIDTH, H - HEIGHT

# STATUS

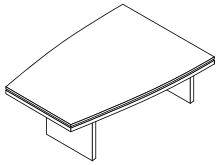

**X 06**  
 2000X1400X760  
 MEDIAPORT:  
 A,B,C / G,H,K

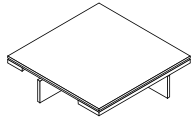

**X 07**  
 1400X1400X760  
 MEDIAPORT:  
 A,B,C / G,H,K

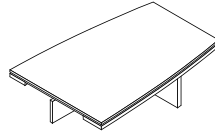

**X 08**  
 2000X1400X760  
 MEDIAPORT:  
 A,B,C / G,H,K



31 / DĄB KANADYJSKI / OAK

## SZAFKI CUPBOARDS

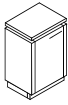

**X 26**  
 544X421X815

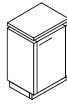

**X 27**  
 544X421X815

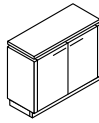

**X 21**  
 1032X421X815

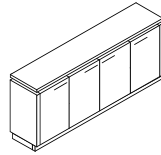

**X 2167**  
 2008X421X815



34 / KASZTAN / CHESTNUT

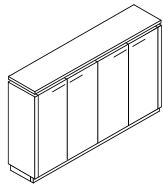

**X 311**  
 2008X421X1167

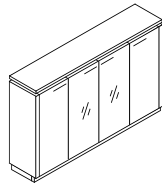

**X 3567**  
 2008X421X1167

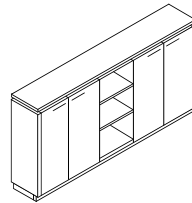

**X 3119**  
 2496X421X1167

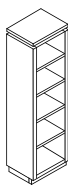

**X 59**  
 544X421X1871

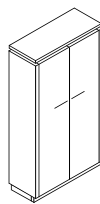

**X 51**  
 1032X421X1871

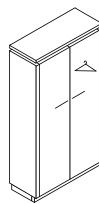

**X 52**  
 1032X421X1871

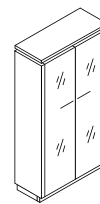

**X 55**  
 1032X421X1871

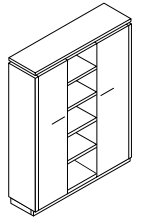

**X 5679**  
 1520X421X1871

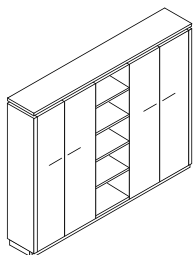

**X 5119**  
 2496X421X1871

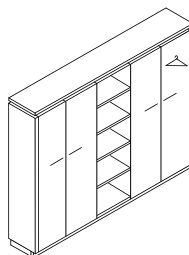

**X 5129**  
 2496X421X1871



23 / ORZECH / NUT



FABRYKA MEBLI BIUROWYCH

[www.mdd.pl](http://www.mdd.pl)

e-mail: [handlowy@mdd.pl](mailto:handlowy@mdd.pl)

[export@mdd.pl](mailto:export@mdd.pl)