

OPUS

OPIS TECHNICZNY

BIURKO, STÓŁ

Blat

plyta melaminowana
28mm

Pogrubiacz

plyta melaminowana
18mm

Noga

plyta melaminowana
28mm

Łączyna

plyta melaminowana
18mm

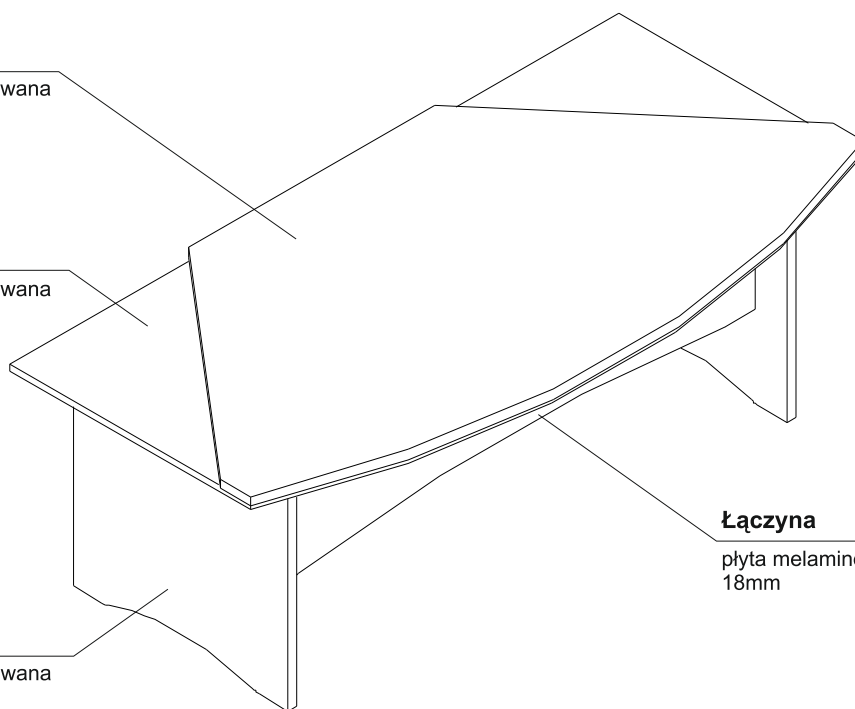

PRZYSTAWKA

Pogrubiacz

plyta melaminowana
18mm

Noga

metal malowany proszkowo
Ø 70mm

Blat

plyta melaminowana
28mm

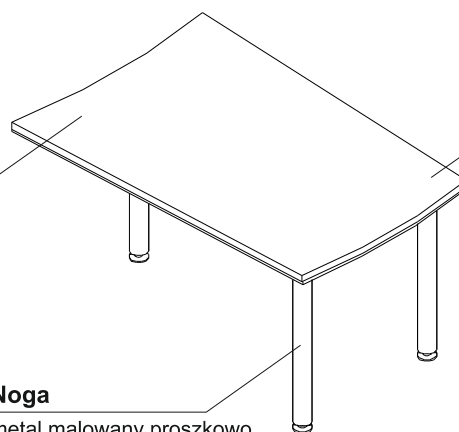

KOMODA

Wieniec górny

plyta melaminowana
28mm

Korpus

plyta melaminowana
18mm



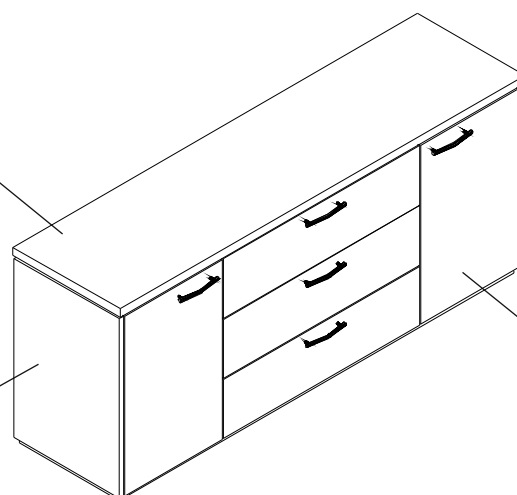

Front

plyta melaminowana
18mm



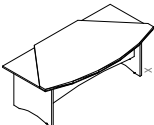

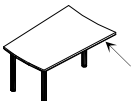
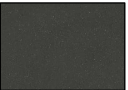
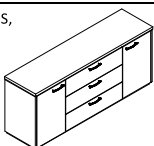
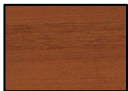
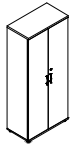
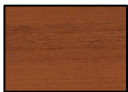



OPUS

KOLORYSTYKA

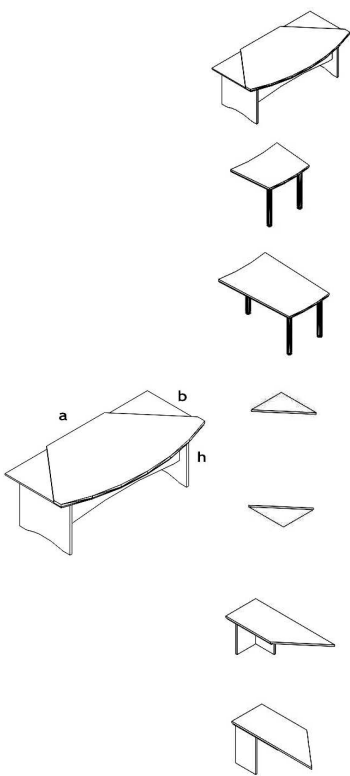
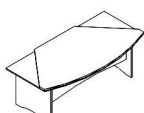
BLAT, ŁĄCZYNA, NOGA PŁYTOWA		 23 - ORZECH
POGRUBIACZ, NOGA METALOWA		 01 - ANTRACYT
WIENIEC GÓRNY, KORPUS, FRONT		 23 - ORZECH
WIENIEC GÓRNY, KORPUS, FRONT		 23 - ORZECH
WIENIEC GÓRNY, KORPUS, FRONT		 23 - ORZECH



WIDOK I RZUT OBIEKTU	WYMIARY			SYMBOL	CENA NETTO PLN	UWAGI
	Szerokość a / a'	Głębokość b / b'	Wysokość h			

BIURKA I ŁĄCZNIKI

		2000	800	738	FP11	995,-	
		930	720	738	FP09	735,-	
		930	1350	738	FP10	985,-	
		600	700	-	FP12	110,-	
		600	700	-	FP13	110,-	
		600	1580	738	FP14	440,-	
		600	1580	738	FP15	440,-	

OPUS





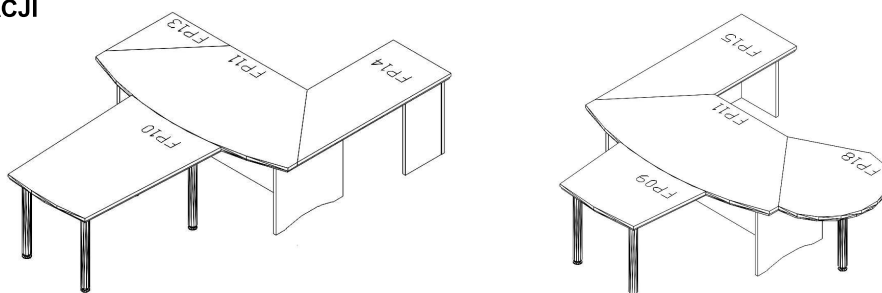

WIDOK I RZUT OBIEKTU	WYMIARY			SYMBOL	CENA NETTO PLN	UWAGI
	Szerokość a / a'	Głębokość b / b'	Wysokość h			

BIURKA I ŁĄCZNIKI						
	1100	1000	738	FP18	500,-	
	1100	1000	738	FP19	500,-	

PRZYKŁADY ARANŻACJI





STOŁY

	2000	1000	738	FP21	1 270,-	
	∅ 1000	-	738	FP23	720,-	
	1400	1100	738	FP24	930,-	
	1400	1100	738	FP25	850,-	
	∅ 800	-	550	FP26	760,-	
	1400	1400	738	FP27	910,-	
	1400	1100	738	FP34	955,-	



OPUS

WIDOK I RZUT OBIEKTU	WYMIARY			SYMBOL	CENA NETTO PLN	UWAGI
	Szerokość a / a'	Głębokość b / b'	Wysokość h			

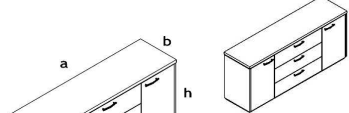

STOŁY

	1400	1100	738	FP35	820,-	
	2000	1000	738	FP41	1 095,-	

KOMODA

	1640	432	740	FP30	1 440,-	
	1400	223	700	FP31	430,-	- panel do zawieszenia za komodą

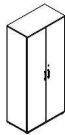
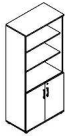
SZAFY I REGAŁY

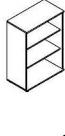
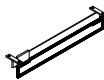
	802	432	1833	A5104C	1 165,-	
	802	432	1833	A5404C	1 040,-	
	802	432	1129	A3104C	855,-	
	802	432	1129	A3504C	555,-	
	-	-	-	S86	20,-	- wieszak wysuwany

KONTENER

	434	600	580	KD13C	800,-	
---	-----	-----	-----	--------------	-------	--