

## IMPULS

### OPIS TECHNICZNY

#### Zastosowane materiały:

- szkło satynowane, hartowane ultra clear (dla białego)
- profil aluminiowy anodowany, malowany proszkowo, z detalami chromowanymi

### BIURKO, PRZYSTAWKA, STOLIKI, STÓŁ

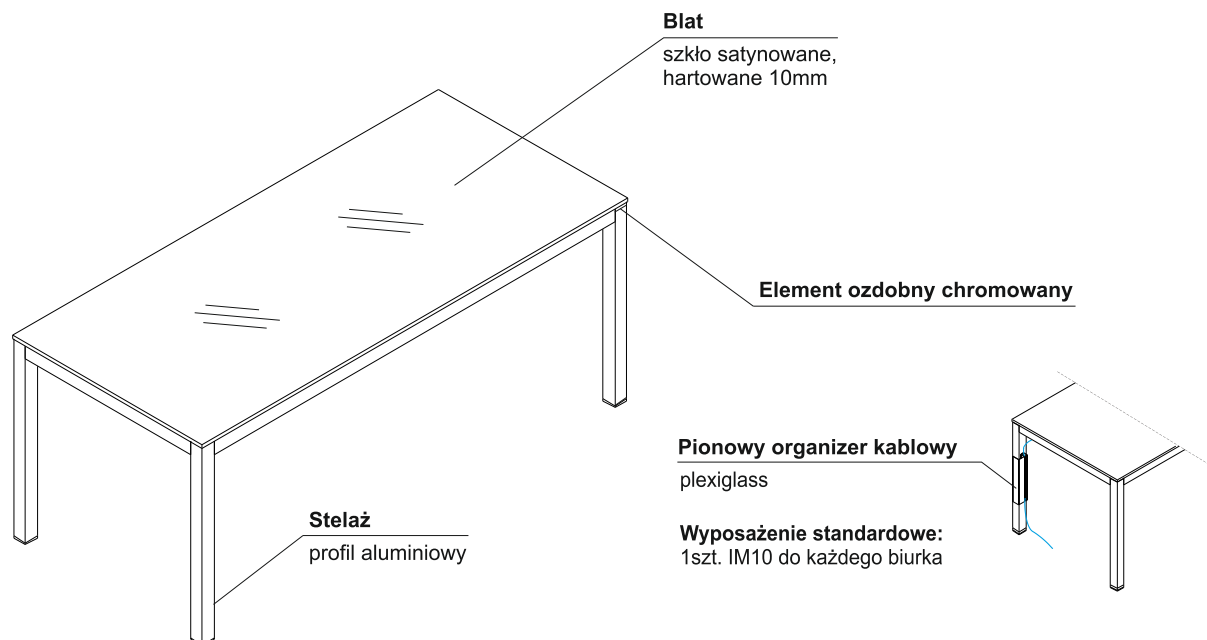

### BLENDY, PRZYSTAWKA

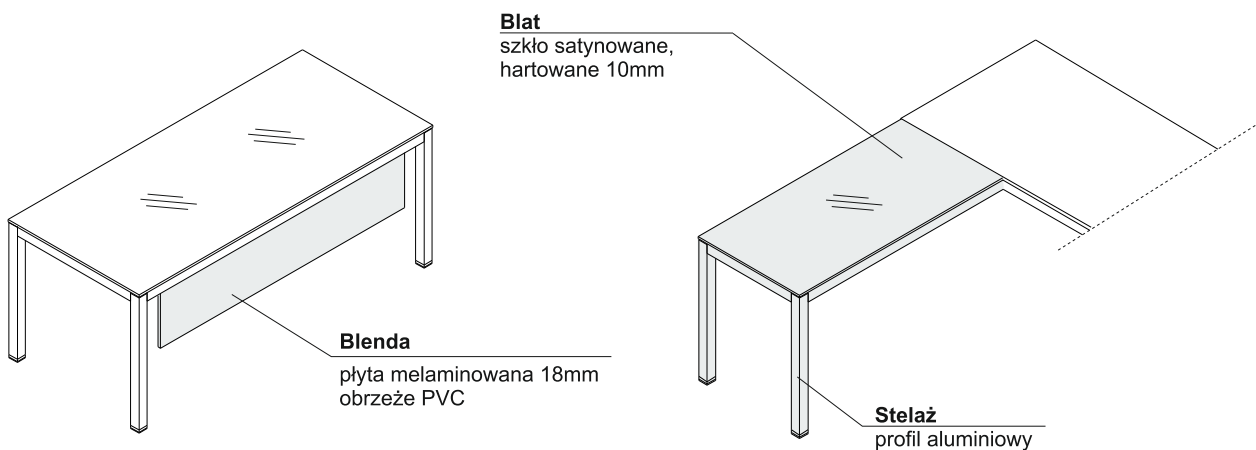

### STOLIK, STÓŁ KONFERENCYJNY

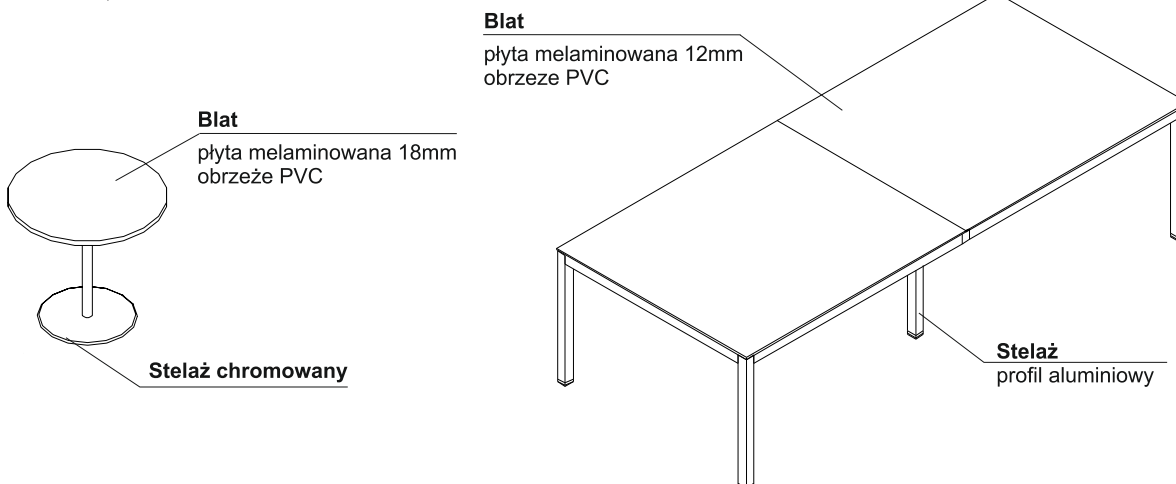

## IMPULS

### OPIS TECHNICZNY

#### SZAFY

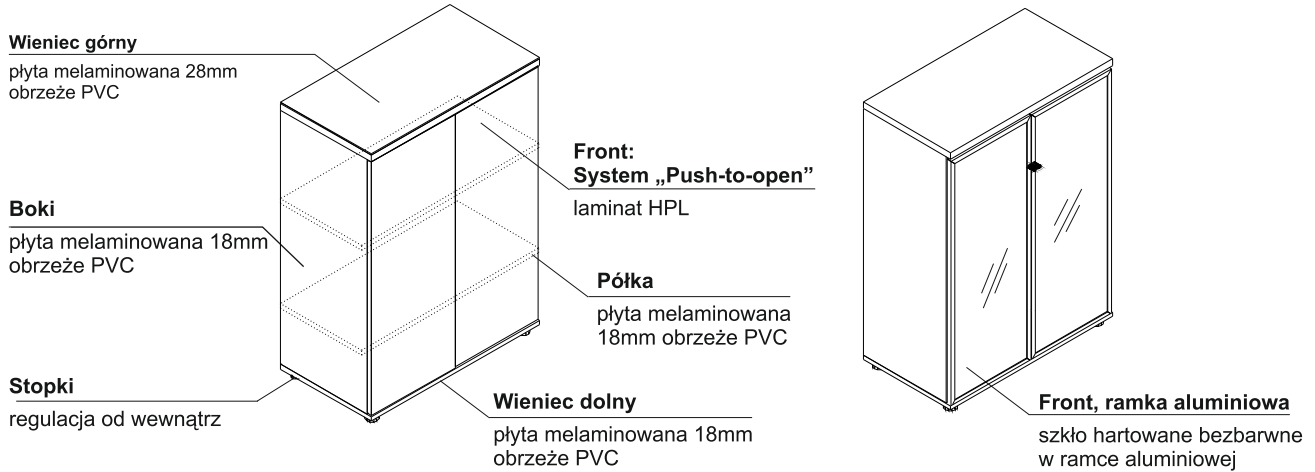

#### KOMODA ZE SZKŁEM

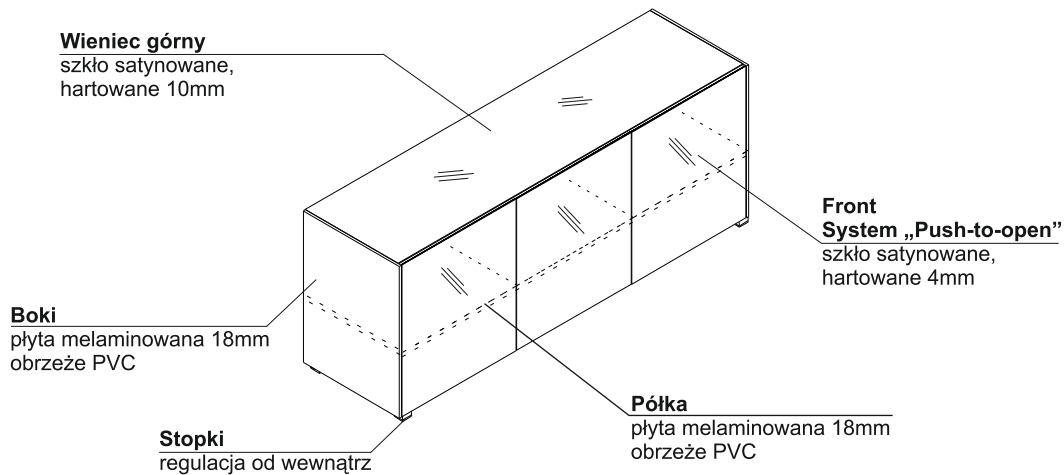



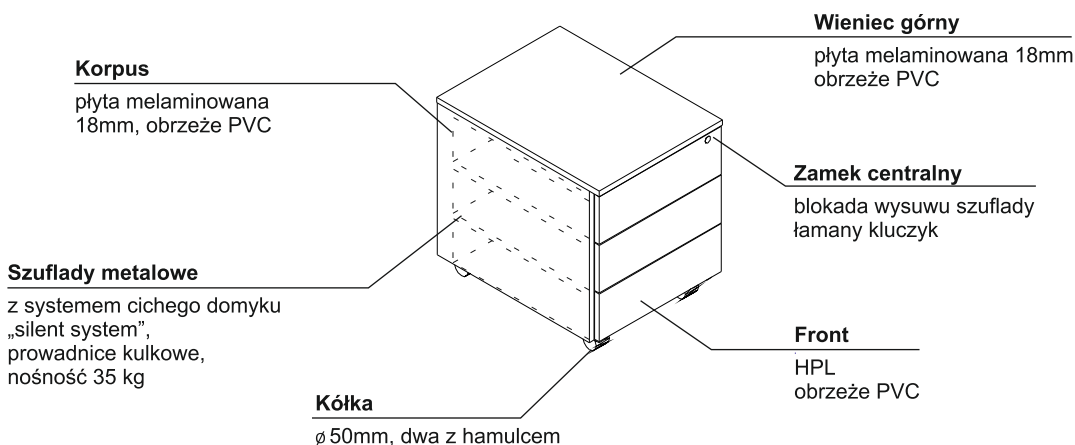



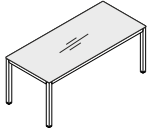

#### KONTENER SLK13H

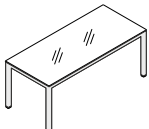
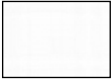

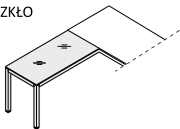

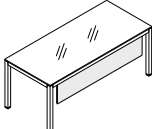



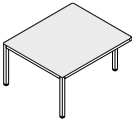
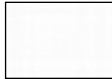

## IMPULS

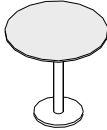
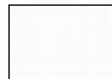
### KOLORYSTYKA – BIURKA, PRYZYSTAWKA

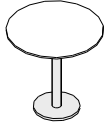
BLAT - SZKŁO 	 117 – SZKŁO BIAŁE	 116 – SZKŁO CZARNE
STELAŻ 	 15 – METAL BIAŁY POŁYSK	 115 – METAL CZARNY POŁYSK
PRYZYSTAWKA - SZKŁO 	 117 – SZKŁO BIAŁE	 116 – SZKŁO CZARNE
OSŁONA 	 67 – BIAŁY PASTEL	 08 – CZARNY

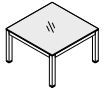
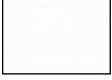
### KOLORYSTYKA – STOŁY, STOLIKI











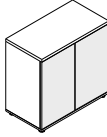

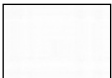

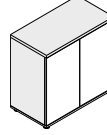
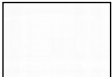

BLAT - MELAMINA 	 67 – BIAŁY PASTEL	 08 – CZARNY
BLAT 	 67 – BIAŁY PASTEL	 08 – CZARNY
STELAŻ 	 17 – CHROM	
BLAT - SZKŁO 	 117 – SZKŁO BIAŁE	 116 – SZKŁO CZARNE

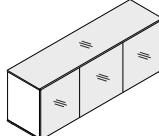
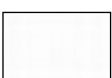
## IMPULS

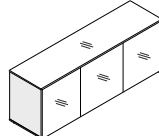
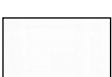
### KOLORYSTYKA - KONTENER SLK13H

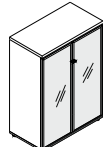
KONTENER SLK13H  WIENIEC GÓRNY I KORPUS		 67 – BIAŁY PASTEL	KONTENER SLK13H  FRONT HPL		 73 – BIAŁY POŁYSK
KONTENER SLK13H  WIENIEC GÓRNY I KORPUS		 08 – CZARNY	KONTENER SLK13H  FRONT HPL		 101 – CZARNY POŁYSK

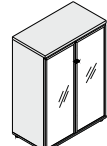
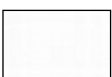
### KOLORYSTYKA SZAF

FRONT HPL		 72 – ZIELONY POŁYSK	 73 – BIAŁY POŁYSK	 74 – POMARAŃCZOWY POŁYSK	 82 – CZERWONY POŁYSK	 101 – CZARNY POŁYSK
WIENIEC GÓRNY I KORPUS		 67 – BIAŁY PASTEL	 08 – CZARNY			
WIENIEC GÓRNY I FRONT – IM20S		 117 – SZKŁO BIAŁE	 116 – SZKŁO CZARNE			
KORPUS – IM20S		 67 – BIAŁY PASTEL	 08 – CZARNY			
FRONT SZKŁO		 SO – SZKŁO BEZBARWNE				
WIENIEC GÓRNY I KORPUS		 67 – BIAŁY PASTEL	 08 – CZARNY			

## IMPULS

WIDOK I RZUT OBIEKTU	WYMIARY (mm)			SYMBOL	CENA NETTO PLN	UWAGI
	Szerokość a / a'	Głębokość b / b'	Wysokość h			

### BIURKA Z BLATEM SZKLANYM

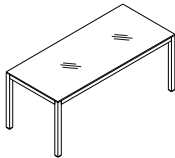
	1600	800	760	<b>IM04S</b>	4 200,-	
	1800	900	760	<b>IM05S</b>	4 500,-	
	2000	900	760	<b>IM06S</b>	4 800,-	

### OSŁONY PŁYTOWE DO BIUREK

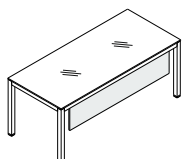
	1400	18	350	<b>IM04B</b>	270,-	
	1600	18	350	<b>IM05B</b>	330,-	
	1800	18	350	<b>IM06B</b>	400,-	

### PRZYSTAWKA DO BIURKA Z BLATEM SZKLANYM

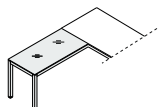
	1200	600	760	<b>IM07S</b>	2 400,-	
--	------	-----	-----	--------------	---------	--

### KONTENER MOBILNY Z FRONTEM HPL

	470	616	580	<b>SLK13H</b>	1 600,-	- płyta melaminowana Front HPL
---	-----	-----	-----	---------------	---------	-----------------------------------

### KOMODA ZE SZKŁEM

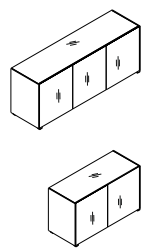
	2000	432	740	<b>IM20S</b>	5 000,-	- wieniec górny i drzwi szkło
	1334	432	740	<b>IM21S</b>	4 100,-	- wieniec górny i drzwi szkło

### STOLIK

	∅ 1000	-	760	<b>IM2</b>	1 500,-	- noga chromowana, blat: płyta melaminowana
---	--------	---	-----	------------	---------	--

### STOLIKI Z BLATEM SZKLANYM

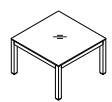
	800	800	500	<b>IM57S</b>	2 500,-	
---	-----	-----	-----	--------------	---------	--

**IMPULS**

WIDOK I RZUT OBIEKTU	WYMIARY (mm)			SYMBOL		UWAGI
	Szerokość a / a'	Głębokość b / b'	Wysokość h			

**SZAFY Z FRONTEM HPL**

	802	432	1833	<b>A5104H</b>	1 690,-	
	802	432	1833	<b>A5404H</b>	1 070,-	
	802	432	1129	<b>A3104H</b>	1 135,-	
	802	432	1129	<b>A3404H</b>	920,-	
	802	432	777	<b>A2104H</b>	835,-	

**WITRYNY**

<p>- drzwi płytowe: System „Push-to-open”</p>	802	432	1833	<b>A5104W</b>	1 765,-	- drzwi szklane w ramce aluminiowej 
	802	432	1833	<b>A5404W</b>	1 530,-	- drzwi szklane w ramce aluminiowej - drzwi z frontem HPL 
	802	432	1129	<b>A3104W</b>	1 135,-	- drzwi szklane w ramce aluminiowej 



Szafy nie posiadają zamka.

## IMPULS

WIDOK I RZUT OBIEKTU	WYMIARY (mm)			SYMBOL		UWAGI
	Szerokość a / a'	Głębokość b / b'	Wysokość h			

### STÓŁ MODUŁOWY

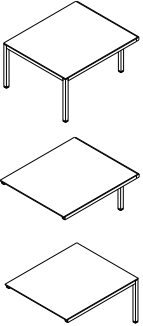
	1200	1400	760	<b>IM53</b>	1 900,-	- element początkowy
	1200	1400	760	<b>IM54</b>	1 600,-	- element środkowy
	1200	1400	760	<b>IM55</b>	1 750,-	- element końcowy

### PRZYKŁADY ARANŻACJI

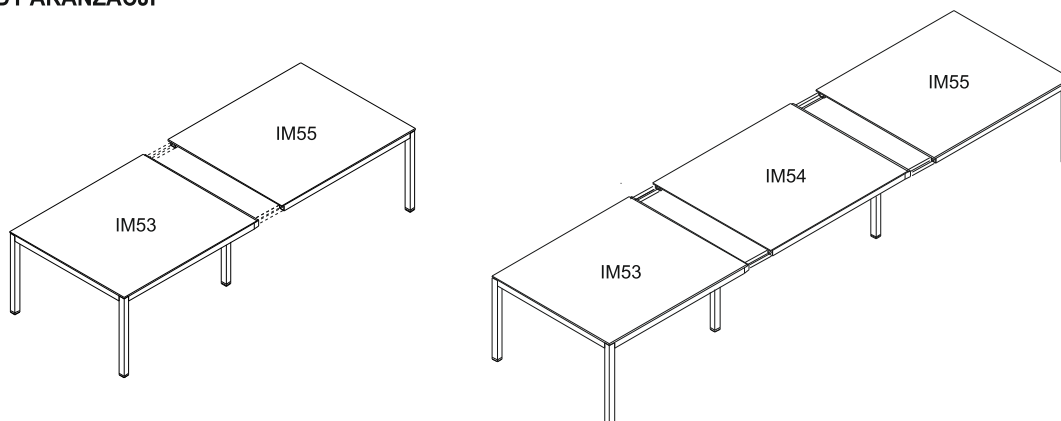

### ELEMENTY DODATKOWE

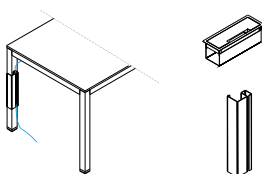
	300	110	110	<b>M01</b>	485,-	- 4 x 230V - 2 x RJ45 09-aluminium - wyłącznie do blatów płytowych
	-	-	350	<b>IM10</b>	50,-	- pionowy organizer kablowy, pleksioglas bezbarwny

### KONFIGURACJA MEDIABOX M01: STOŁY MODUŁOWE



- możliwość usytuowania w jednym miejscu (M)
- opcję należy dopisać na końcu symbolu oraz doliczyć wartość mediabox M01 do ceny biurka:  
np.

IM53M = 1 900 zł + 485zł = 2 385zł

## IMPULS

### OPIS TECHNICZNY

#### Zastosowane materiały:

- płyta melaminowana
- profil aluminiowy anodowany, malowany proszkowo, z detalami chromowanymi

#### BIURKO, PRZYSTAWKA, STOLIKI, STÓŁ

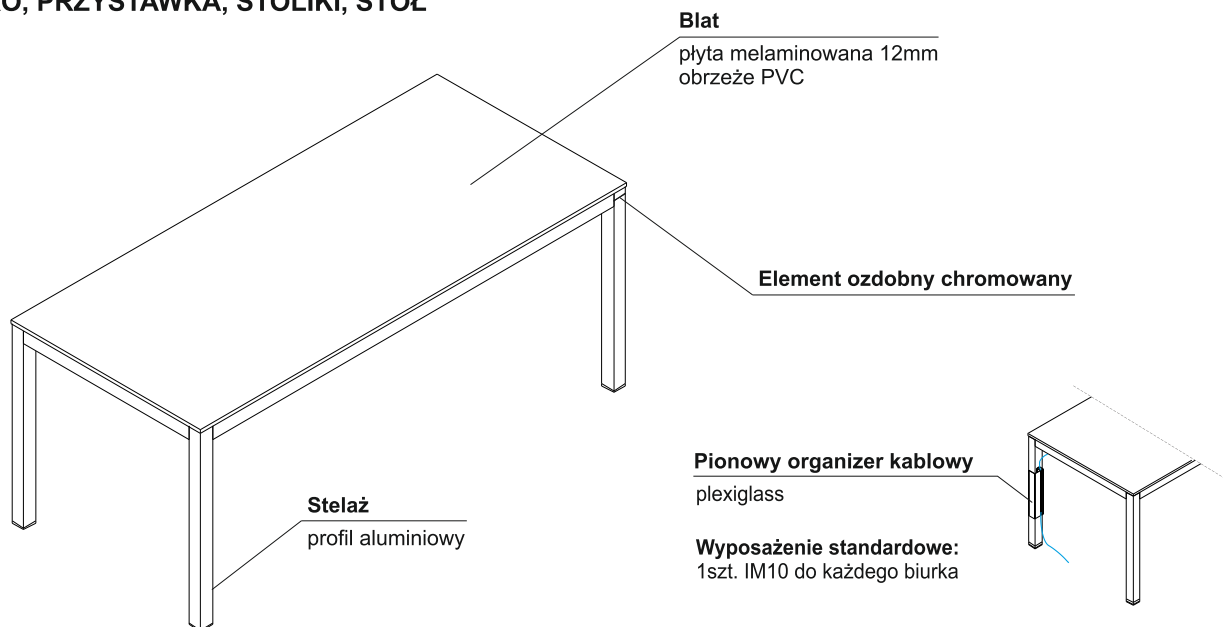

#### BLENDY, PRZYSTAWKA

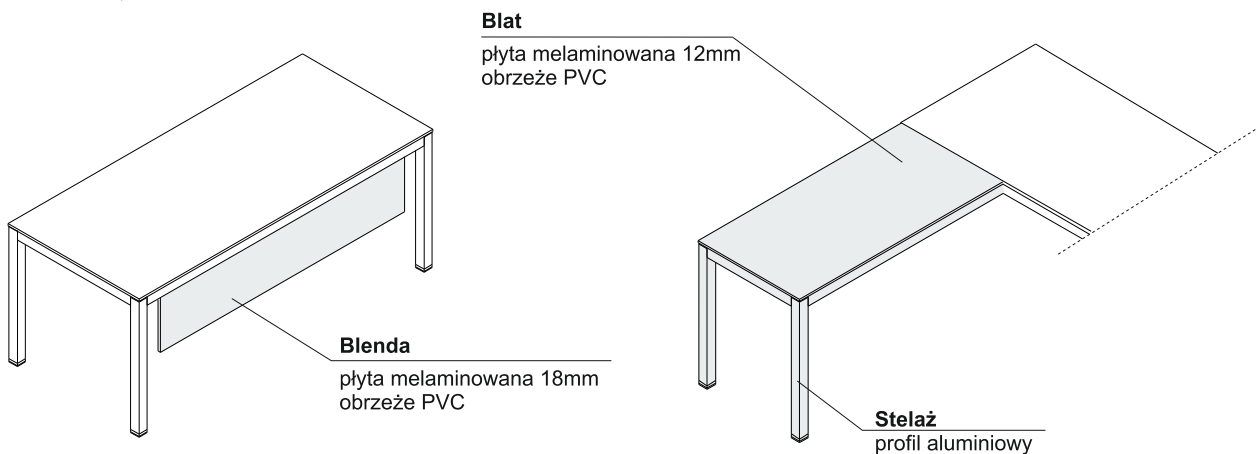

#### STOLIK, STÓŁ KONFERENCYJNY

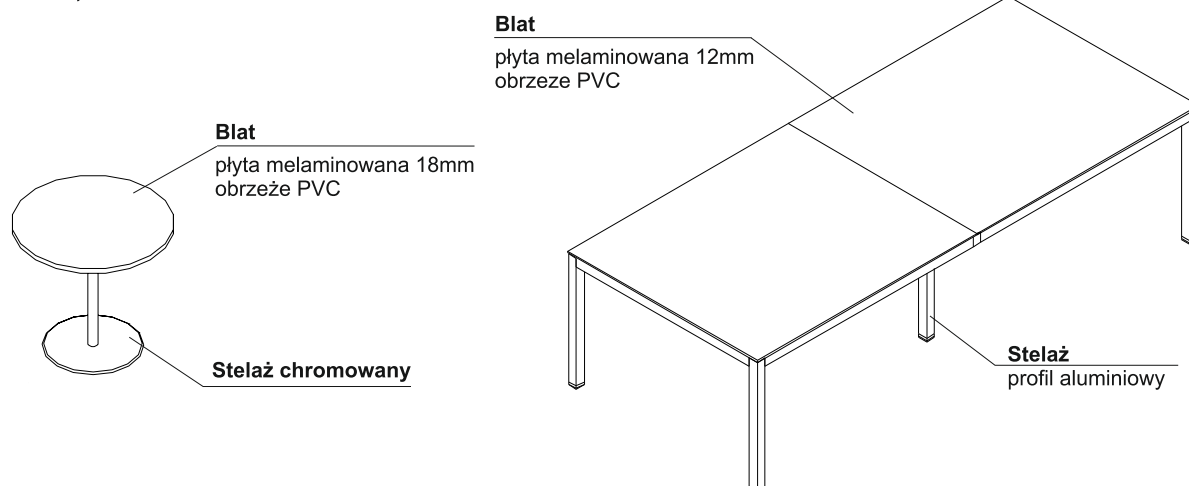

## IMPULS

### OPIS TECHNICZNY

#### SZAFY

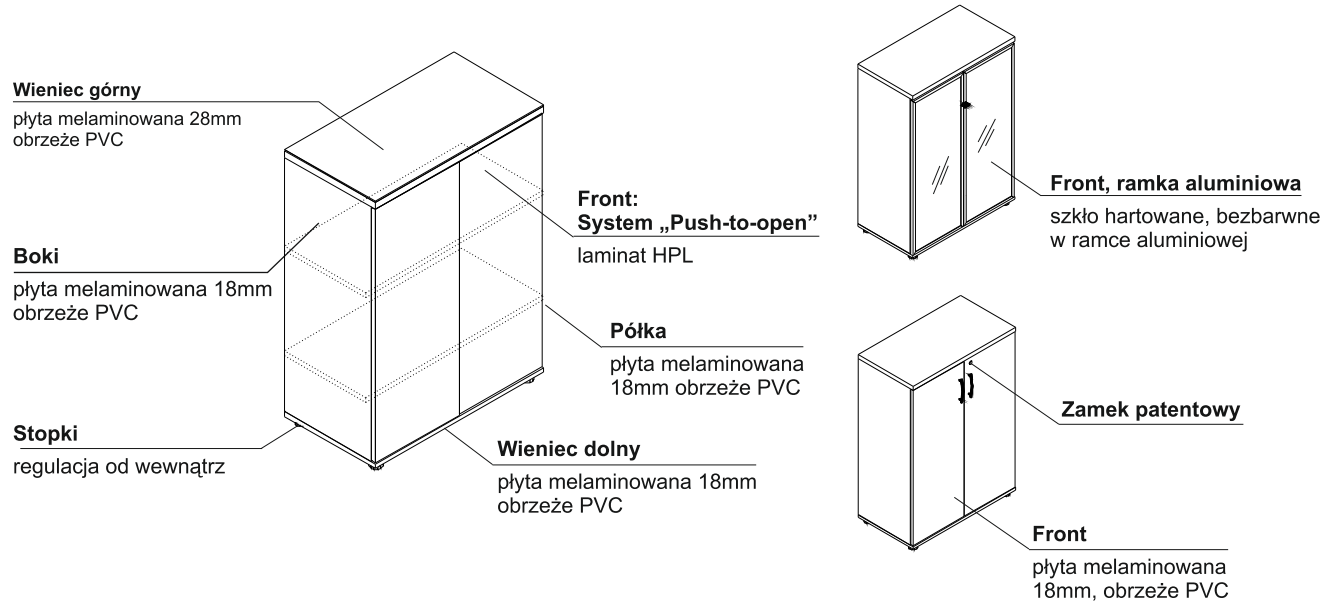

#### KOMODA, SZAFKA ZS02, ZS03

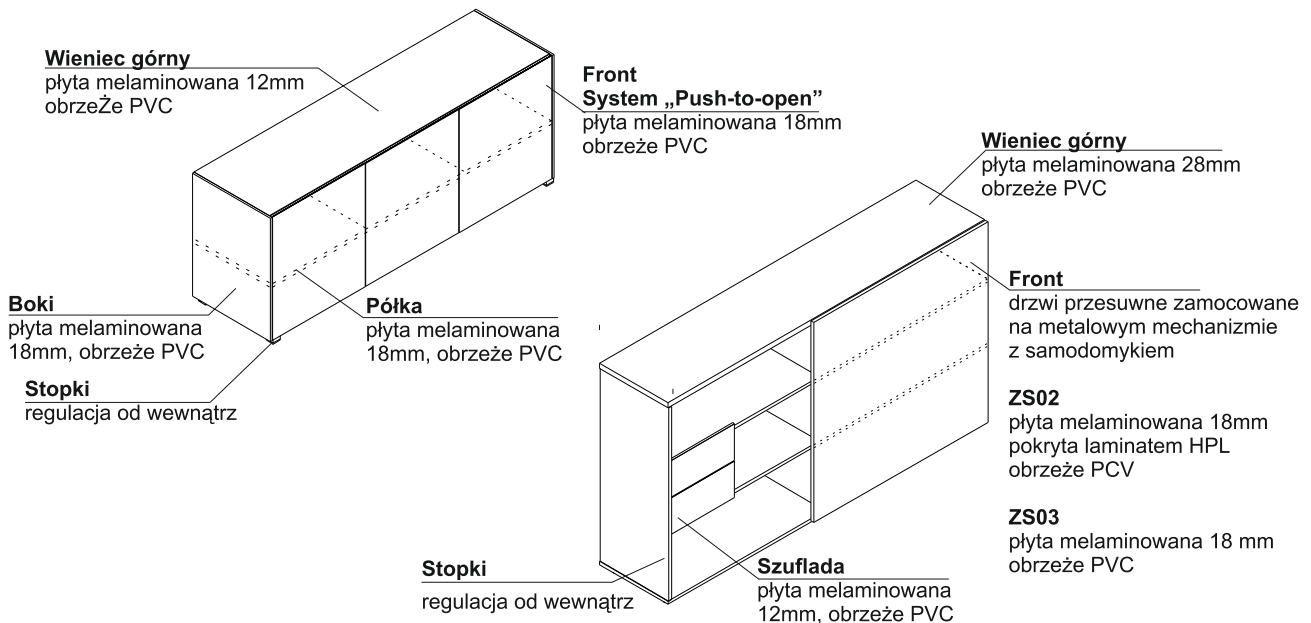

#### KONTENER SLK13H

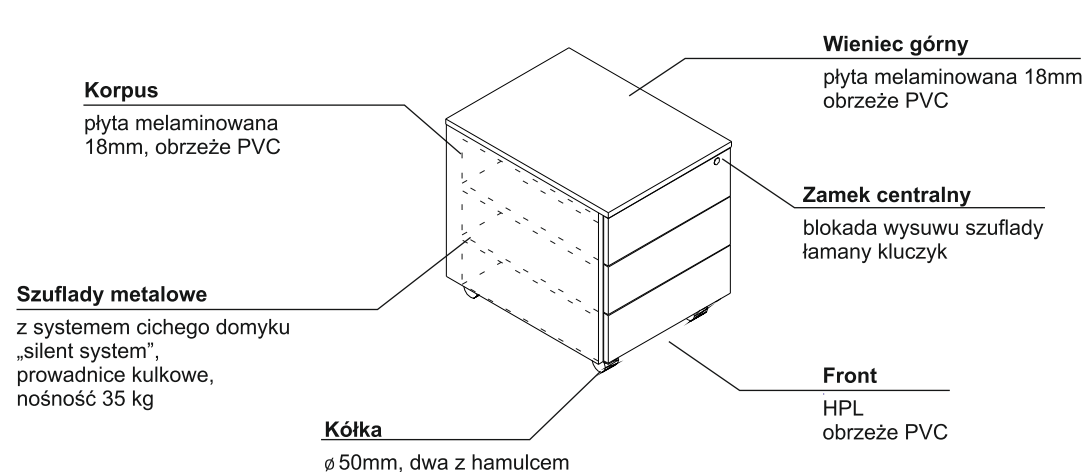

## IMPULS

### KOLORYSTYKA – BIURKA, PRYZSTAWKA

BLAT - MELAMINA 	 31 – DĄB KANADYJSKI	 34 – KASZTAN	 67 – BIAŁY PASTEL
STELAŻ 	 15 – METAL BIAŁY POŁYSK	 115 – METAL CZARNY POŁYSK	
PRYZSTAWKA - MELAMINA 	 31 – DĄB KANADYJSKI	 34 – KASZTAN	 67 – BIAŁY PASTEL
OSŁONA 	 67 – BIAŁY PASTEL	 08 – CZARNY	

### KOLORYSTYKA – STOŁY, STOLIKI





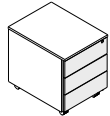





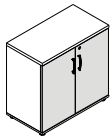



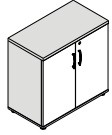



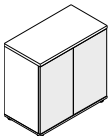





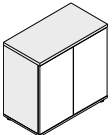
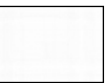

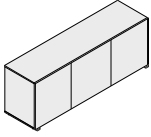

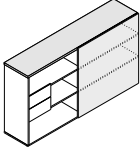

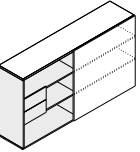
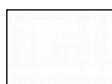
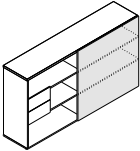

BLAT 	 31 – DĄB KANADYJSKI	 34 – KASZTAN	 67 – BIAŁY PASTEL
BLAT 	 31 – DĄB KANADYJSKI	 34 – KASZTAN	 67 – BIAŁY PASTEL
STELAŻ 	 17 – CHROM		
BLAT 	 31 – DĄB KANADYJSKI	 34 – KASZTAN	 67 – BIAŁY PASTEL

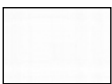
### KOLORYSTYKA – KONTENER SLK13H

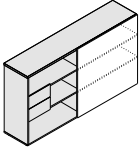
KONTENER SLK13H WINIEC GÓRNY I KORPUS 	 67 – BIAŁY PASTEL	KONTENER SLK13H FRONT HPL 	 73 – BIAŁY POŁYSK
KONTENER SLK13H WINIEC GÓRNY I KORPUS 	 08 – CZARNY	KONTENER SLK13H FRONT HPL 	 101 – CZARNY POŁYSK

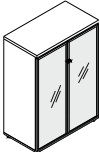
## IMPULS

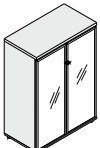
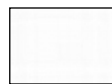
### KOLORYSTYKA SZAF

FRONT						
		31 – DĄB KANADYJSKI	34 – KASZTAN	67 – BIAŁY PASTEL		
WIENIEC GÓRNY I KORPUS						
		31 – DĄB KANADYJSKI	34 – KASZTAN	67 – BIAŁY PASTEL		
FRONT HPL						
		72 – ZIELONY POŁYSK	73 – BIAŁY POŁYSK	74 – POMARAŃCZOWY POŁYSK	82 – CZERWONY POŁYSK	101 – CZARNY POŁYSK
WIENIEC GÓRNY I KORPUS						
		67 – BIAŁY PASTEL	08 – CZARNY			
KOMODA 1M20						
		31 – DĄB KANADYJSKI	34 – KASZTAN			
WIENIEC GÓRNY I FRONT – ZS03						
		31 – DĄB KANADYJSKI	34 – KASZTAN	67 – BIAŁY PASTEL		
KORPUS – ZS03						
		67 – BIAŁY PASTEL				
FRONT HPL – ZS02						
		72 – ZIELONY POŁYSK	73 – BIAŁY POŁYSK	74 – POMARAŃCZOWY POŁYSK	82 – CZERWONY POŁYSK	
WIENIEC GÓRNY I KORPUS – ZS02						
		67 – BIAŁY PASTEL				
FRONT SZKŁO						
		50 – SZKŁO BEZBARWNE				
KORPUS						
		67 – BIAŁY PASTEL	08 – CZARNY			

## IMPULS

WIDOK I RZUT OBIEKTU	WYMIARY (mm)			SYMBOL		UWAGI
	Szerokość a / a'	Głębokość b / b'	Wysokość h			

### BIURKA Z BLATEM PŁYTOWYM

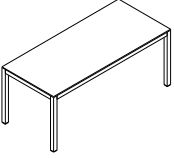
	1600	800	760	<b>IM04</b>	1 900,-	
	1800	900	760	<b>IM05</b>	2 000,-	
	2000	900	760	<b>IM06</b>	2 150,-	

### OSŁONY PŁYTOWE DO BIUREK

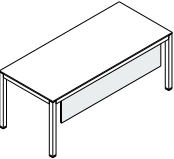
	1400	18	350	<b>IM04B</b>	270,-	
	1600	18	350	<b>IM05B</b>	330,-	
	1800	18	350	<b>IM06B</b>	400,-	

### PRZYSTAWKA DO BIURKA Z BLATEM PŁYTOWYM

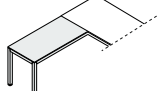
	1200	600	760	<b>IM07</b>	1 250,-	
--	------	-----	-----	-------------	---------	--

### KONTENER MOBILNY Z FRONTEM HPL

	470	616	580	<b>SLK13H</b>	1 600,-	- płyta melaminowana Front HPL
---	-----	-----	-----	---------------	---------	-----------------------------------

### KOMODA

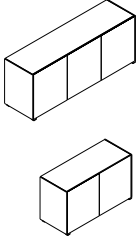
	2000	432	740	<b>IM20</b>	3 000,-	
	1334	432	740	<b>IM21</b>	2 500,-	

### STOLIK

	∅ 1000	-	760	<b>IM2</b>	1 500,-	- noga chromowana, blat: płyta melaminowana
---	--------	---	-----	------------	---------	--

### STOLIKI Z BLATEM PŁYTOWYM

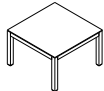
	800	800	500	<b>IM57</b>	1 650,-	
---	-----	-----	-----	-------------	---------	--

**IMPULS**

WIDOK I RZUT OBIEKTU	WYMIARY (mm)			SYMBOL		UWAGI
	Szerokość a / a'	Głębokość b / b'	Wysokość h			

**SZAFY Z FRONTEM HPL**

	802	432	1833	<b>A5104H</b>	1 690,-	
	802	432	1833	<b>A5404H</b>	1 070,-	
	802	432	1129	<b>A3104H</b>	1 135,-	
	802	432	1129	<b>A3404H</b>	920,-	
	802	432	777	<b>A2104H</b>	835,-	

**SZAFY Z UCHWYTEM**

	802	432	1833	<b>A5104C</b>	1 085,-	
	802	432	1833	<b>A5404C</b>	970,-	
	802	432	1129	<b>A3104C</b>	795,-	
	802	432	1129	<b>A3504C</b>	515,-	
	802	432	777	<b>A2104C</b>	625,-	







Szafy nie posiadają zamka.

## IMPULS

WIDOK I RZUT OBIEKTU	WYMIARY (mm)			SYMBOL		UWAGI
	Szerokość a / a'	Głębokość b / b'	Wysokość h			

### WITRYNY

 <p>- drzwi płytowe: System „Push-to-open”</p>	802	432	1833	<b>A5104W</b>	1 765,-	- drzwi szklane w ramce aluminiowej 
	802	432	1833	<b>A5404W</b>	1 530,-	- drzwi szklane w ramce aluminiowej - drzwi z frontem HPL 
	802	432	1129	<b>A3104W</b>	1 135,-	- drzwi szklane w ramce aluminiowej 

### SZAFY Z DRZWIAMI PRZESUWNymi

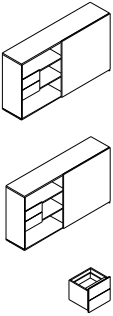
	2000	434	1129	<b>ZS02</b>	2 025,-	- front HPL
	2000	432	1129	<b>ZS03</b>	1 705,-	- front melamina
	428	385	403	<b>ZSZ01</b>	280,-	- szuflada do szaf



Szafy nie posiadają zamka.

## IMPULS

WIDOK I RZUT OBIEKTU	WYMIARY (mm)			SYMBOL		UWAGI
	Szerokość a / a'	Głębokość b / b'	Wysokość h			

### STÓŁ MODUŁOWY

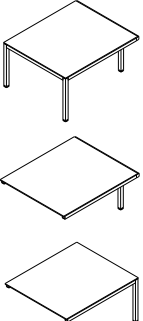
	1200	1400	760	<b>IM53</b>	1900,-	- element początkowy
	1200	1400	760	<b>IM54</b>	1600,-	- element środkowy
	1200	1400	760	<b>IM55</b>	1750,-	- element końcowy

### PRZYKŁADY ARANŻACJI

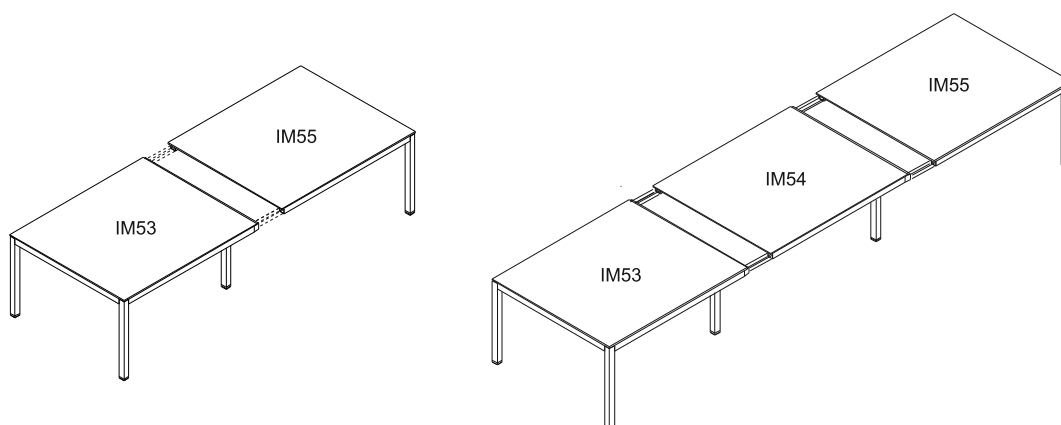

### ELEMENTY DODATKOWE

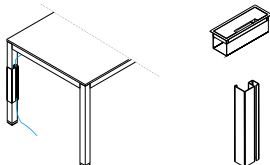
	300	110	110	<b>M01</b>	485,-	- 4 x 230V - 2 x RJ45 - 09-aluminium - wyłącznie do blatów płytowych
	-	-	350	<b>IM10</b>	50,-	- pionowy organizator kablowy, pleksioglas bezbarwny

### KONFIGURACJA MEDIABOX M01: BIURKA Z BLATEM PŁYTOWYM



- możliwość usytuowania w jednym miejscu (M)
- opcję należy dopisać na końcu symbolu oraz doliczyć wartość mediabox M01 do ceny biurka:  
np.

$$IM06M = 1\ 980\ \text{zł} + 485\ \text{zł} = 2\ 465\ \text{zł}$$

### KONFIGURACJA MEDIABOX M01: STOŁY MODUŁOWE



- możliwość usytuowania w jednym miejscu (M)
- opcję należy dopisać na końcu symbolu oraz doliczyć wartość mediabox M01 do ceny biurka:  
np.

$$IM53M = 1\ 900\ \text{zł} + 485\ \text{zł} = 2\ 385\ \text{zł}$$